

# FLAT GLASS WATER GAGES

## 450 - 2000 PSI

FEATURING  
**MICA PROTECTION & HEAVY DUTY CONSTRUCTION**

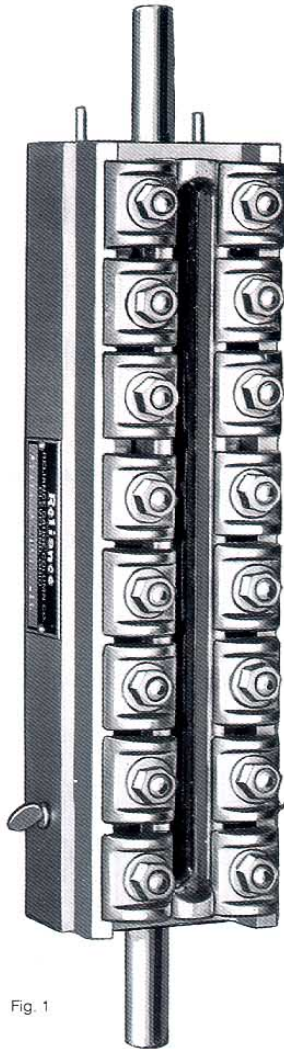

Fig. 1

*The precision manufacturing of these time-tested designs assures outstanding performance and service life. Choose from single, double, or triple windows for ultimate visibility.*

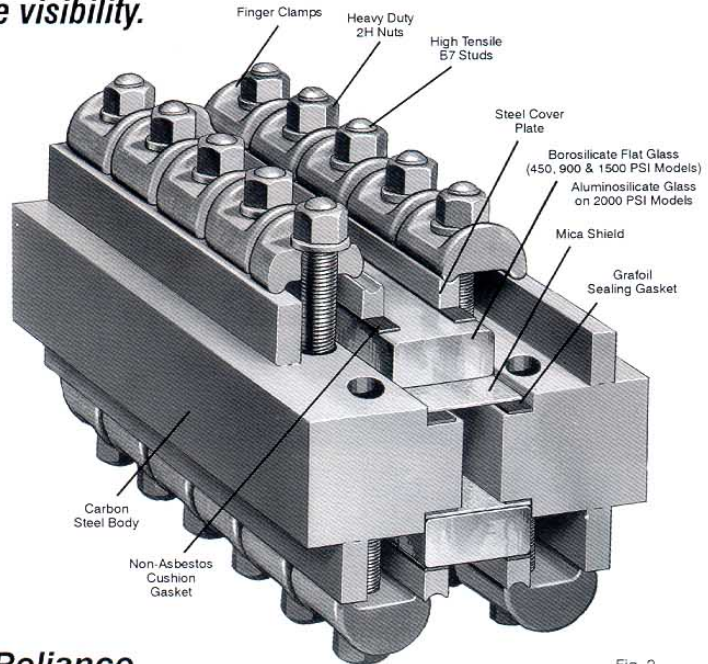

Fig. 2

### **Clark-Reliance FG Series Flat Glass Gages feature four functional designs.**

FG Series Gages provide wide-body construction for added strength and rigidity. Tempered flat glass composition of premium quality to resist thermal shock. All glass is tested for surface trueness prior to assembly and is protected with a high quality mica shield for steam applications.

All models feature finger-clamps which impart a uniform, perpendicular load across the glass surface, assuring gasket tightness. This design allows easy dismantling for cleaning and servicing.

A window slot, 5/8" wide, provides high visibility gage reading. For many installations, *Water Gage Illuminators* are recommended to improve gage readability. **See inside for specifications.**

# TO 450 PSI

(31 Bar G, 31.6 Kg/cm<sup>2</sup>)

## SINGLE WINDOW GAGES

MODEL NUMBER	VISIBILITY		MINIMUM WATER GAGE CENTERS			
			404RS		SG854	
	INCHES	MM	INCHES	MM	INCHES	MM
FG404	6-5/8	168	14	356	17	432
FG405	7-3/4	197	16	406	18	457
FG406	9	229	17	432	20	508
FG407	10-1/8	257	18	457	21	533
FG408	11-3/4	298	20	508	22	559
FG409	12-1/2	318	20	508	23	584

## DOUBLE WINDOW GAGES

FG466	15	381	24	610	26	660
FG477	17-1/2	444	26	660	29	737
FG488	20	508	29	737	31	787
FG499	21-1/2	546	30	762	33	838

Three or more window models available upon request.

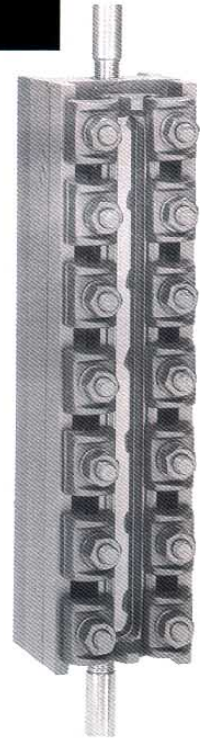

Fig. 3

# TO 900 PSI

(62.1 Bar G, 63.27 Kg/cm<sup>2</sup>)



Fig. 4

## SINGLE WINDOW GAGES

MODEL NUMBER	VISIBILITY		MINIMUM WATER GAGE CENTERS	
	INCHES	MM	INCHES	MM
FG904	6-5/8	168	17	432
FG905	7-3/4	197	18	457
FG906	9	229	20	508
FG907	10-1/8	257	21	533
FG908	11-3/4	298	22	559
FG909	12-1/2	318	23	584

## DOUBLE WINDOW GAGES

FG966	15	381	26	666
FG977	17-1/2	444	29	737
FG988	20	508	31	787
FG999	21-1/2	546	33	838

\*Minimum centers quoted apply to Clark-Reliance Gage Valve Series SG854/SG860.

# TO 1500 PSI

(103.4 Bar G, 105.5 Kg/cm<sup>2</sup>)



Fig. 5

## SINGLE WINDOW GAGES

MODEL NUMBER	VISIBILITY		MINIMUM WATER GAGE CENTERS	
	INCHES	MM	INCHES	MM
FG1504	6-5/8	168	20	508
FG1505	7-3/4	197	21	533
FG1506	9	229	23	584
FG1507	10-1/8	257	24	609
FG1508	11-3/4	298	25	635
FG1509	12-1/2	318	26	660

## DOUBLE WINDOW GAGES

FG1566	15	381	29	737
FG1577	17	432	31	787
FG1588	19-1/2	495	33	838
FG1599	21	533	35	889

Three or more window models available upon request.

\*Minimum centers quoted apply to Clark-Reliance Gage Valve Series SG854/SG860.

# TO 2000 PSI

(138 Bar G, 140.6 Kg/cm<sup>2</sup>)

## SINGLE WINDOW GAGES

MODEL NUMBER	VISIBILITY		MINIMUM WATER GAGE CENTERS	
	INCHES	MM	INCHES	MM
FG2004	6-5/8	168	15	381
FG2005	7-3/4	197	16	406
FG2006	9	229	17	432
FG2007	10-1/8	257	19	483

## DOUBLE WINDOW GAGES

FG2055	12	305	20	508
FG2066	15	381	23	584
FG2077	17	432	25	635

Three or more window models available upon request.

\*Minimum centers quoted apply to Clark-Reliance Gage Valve Series SG700, with flanged water gage connections, and no expansion loop.

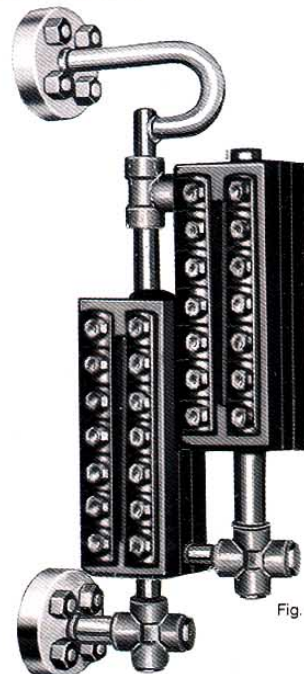
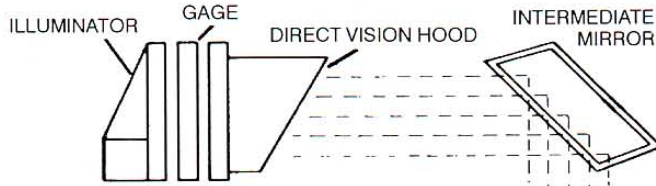

Fig. 6

# WATER GAGE ILLUMINATORS

## Increased Visibility For Flat Glass Gages



**Direct Vision Installations**

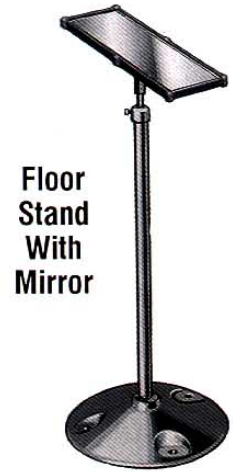

**Floor Stand With Mirror**

**Intermediate Mirrors**



**FLOOR STAND MIRROR**



**Flat Glass With Direct Vision Hoods With Horizontal Type Illuminators**

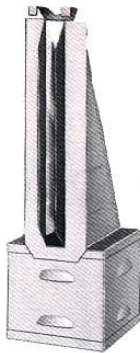

**Flat Glass Mercury Lamp Illuminators**

Recommended for gages at elevations beyond 25 feet.



**Flat Glass With Vertical Design Illuminator & Weatherproof Illuminator Hood**

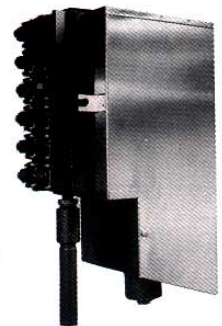

This Represents Only A Portion Of Our Water Gage Illuminators.

Please Refer To Catalog 500 Section AB8.1A For A Complete Listing.

For additional information, contact your local Clark-Reliance representative

# Clark-Reliance®

16633 FOLTZ INDUSTRIAL PARKWAY • STRONGSVILLE, OHIO 44136-5597 • USA  
TELEPHONE: (440) 572-1500 • FACSIMILE: (440) 238-8828 • www.clark-reliance.com

